

PLEION
Il n.1 del Solare Termico in Italia!



WHITE FLAT
TECHNOLOGY

ECLIPSE 2

THE FIRST **SMART** SOLAR COLLECTOR

www.pleion.it

The revolutionary solar collector
with PLEION **ECLIPSE 2 COVER SYSTEM**.

Say goodbye, forever, to overtemperature and stagnation.



ECLIPSE in OPEN/CLOSED mode
with ECLIPSE CONTROLLER



The greatest limits of an evacuated solar collector have always been overtemperature and stagnation.

PLEION ECLIPSE 2 COVER SYSTEM is the world's first solar collector endowed with a smart Auto Dimming system that regulates the collector temperature and keeps your solar system perfectly efficient all year round.

Designers, installers and users can finally fully enjoy the advantages of the thermal solar avoiding overtemperature.



What is stagnation in thermal solar collectors?

In the seasons when solar irradiation is strong or when the solar system is not in use, the captured solar energy may exceed the amount the vector fluid is able to store in the boiler as heat; in other words, temperature exceeds the quantity needed by the user.

This phenomenon is called STAGNATION.

If circulation is missing the temperature of the vector fluid becomes so high (up to 250°C) that the conditions for the solar collector and the other components interacting with the fluid become critical (solar pipes, circulation pumps, safety valves).

The system is usually built to resist occasional occurrences of such conditions but if the phenomenon takes place very often the efficiency and functionalities of the system may be at risk, in that the vector fluid or other components may deteriorate.

The PLEION ECLIPSE 2 COVER SYSTEM evacuated solar collector totally prevents stagnation and your solar system will always work at top efficiency.

PLEION
Il n.1 del Solare Termico in Italia!

The revolutionary solar collector with PLEION **ECLIPSE 2 COVER SYSTEM**.

Different from all, it is exactly what you've been waiting for.

ENGINE
PROTECTIVE CARTER



Creating a dimming system is easy. What is difficult is to produce a smart system that does it all on its own and guarantees maximum safety.

Designing the new ECLIPSE we considered all the elements that define an evacuated solar collector and we aimed at creating something totally new, something radically different from what came before.

A great idea: ECLIPSE 2 is unlike any other solar collector in the world.

ECLIPSE is optimised for top performances. For the first time a solar collector is built to maximise thermal efficiency. Instead of using fans, heat sinks or other conventional solutions, in order to control overtemperature we developed a new dimming system with rotating sheets, commanded by an electronic unit with microprocessor.



ECLIPSE with OPEN CLOSED.



ECLIPSE with CLOSED CLOSED.

The core of ECLIPSE 2 is a solar collector made of 14 PLEION X-AIR evacuated pipes, by the strictest european lab standards.

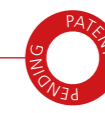

PATENTED TRANSMISSION SYSTEM

EVACUATED SOLAR COLLECTOR

ROTATING DIMMING SHEETS



SMART CONTROL

PLEION ECLIPSE COVER SYSTEM Control is intelligent and automatically adjusts according to the temperature in the collector and the boiler. The "HOLIDAY" mode allows manual adjustment when the system is not in use.



EFFICIENT ALL YEAR ROUND.

The solar system is exploited 365 days a year and protected when not in use or irradiation is excessive (without having to unload the system).



Collector and system are more durable with ECLIPSE.

Longer durability and lower servicing costs than any other collector in the market.



PLUG&PLAY

PLEION ECLIPSE COVER SYSTEM and its control module are rapidly installed without the need of an electrician.

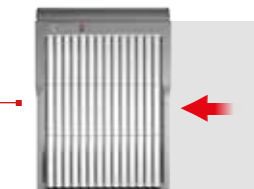

IMPROVED PERFORMANCE WITH THE "WHITE FLAT" TECHNOLOGY

The new ECLIPSE2 has a new rear panel in aluminium which has been subjected to a special reflecting treatment, and this allows for exploiting even diffused light, improving yield and performance especially in the colder seasons when the need for hot water is greater.

The revolutionary solar collector
with PLEION **ECLIPSE 2 COVER SYSTEM**.

Until yesterday it was impossible, now it is here: ECLIPSE 2.



The operating principle of PLEION ECLIPSE 2 COVER SYSTEM
is as simple as clever: a **patented rotating dimming system**
and an **intelligent controller**.

ECLIPSE 2 is different from any other product we have ever created.
Yet, we wanted it to be easy and intuitive to use. So we invented a sophisticated
controller but we made it extremely user-friendly.

The result? A system that checks solar collector efficiency 24 hours a day, and intervenes
when necessary, to let you enjoy the advantages of thermal solar energy without preoccupations

ECLIPSE 2 SMART CONTROLLER:
the intelligent unit that protects your system
from overtemperature and stagnation
24/7, 365 days!



BLUE LIGHT - AUTO SMART

"HOLIDAY" MODE

ECLIPSE 2 STATUS OPEN, THE SOLAR
SYSTEM OPERATES REGULARLY AND
GUARANTEES BEST EFFICIENCY AND
PERFORMANCE.

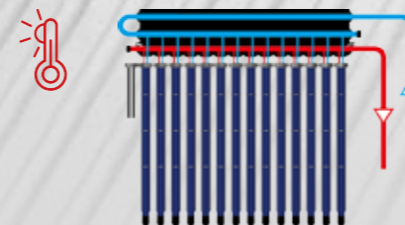

AUTO

AUTO SMART
Carefree, everything is automatic.

In case of high irradiation (overtemperature risk)
ECLIPSE 2 SMART CONTROLLER automatically positions
the sheets in "dimming" mode, preventing sun rays from
raising the vector fluid temperature any further,
thus stabilising the system temperature.

The system automatically detects when to resume energy
capturing and allowing the heating of the vector fluid,
thus restoring the normal operation of the system

OVERTEMPERATURE RISK,
ECLIPSE 2 AUTOMATICALLY CLOSES
THE DIMMING SHEETS.

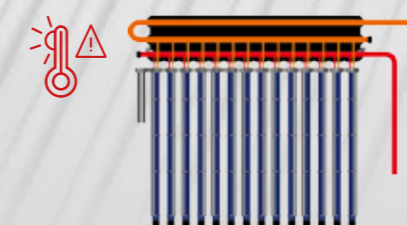

MANUAL

HOLIDAY - MANUAL
Safety at fingertips.

In case you do not use the system for extended periods
of time, you can simply press a button to activate the
"HOLIDAY" mode: the sheets of ECLIPSE 2 close and
protect the pipes from the sun and the elements (ANTI-HAIL
SYSTEM) until it the system used again.

This mode is perfect for the systems that are used only
a few months a year or close during the summer (such
as schools, sports centres, hotels, campsites or holiday
houses).

The dimming sheets prevent the sun from
heating up the system further.

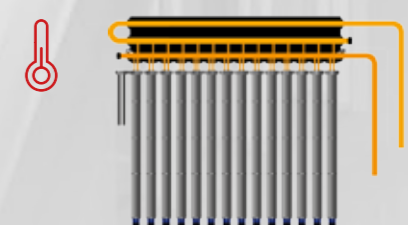

The revolutionary solar collector with PLEION **ECLIPSE 2 COVER SYSTEM**.



Great power, super efficiency.



The core of **ECLIPSE 2 COVER SYSTEM** is a **PLEION 14-pipe evacuated collector** guaranteeing high performance for any needs of hot water and heating integration.

Try out the new collectors with integrated third pipe **PLEION ECLIPSE 2 COVER SYSTEM**. Every collector is shipped pre-assembled, with 14 tempered-glass evacuated pipes with a high-absorbency treatment. The pipes have a 10-year anti-hail warranty. If necessary, they can be replaced without unloading the system – this means reduced servicing during the whole life of the collector. Light and compact frame for easy installation, its design makes it one of the most efficient collectors in its category.

- Third integrated pipe
- High annual efficiency per surface unit
- Light and compact frame for easy installation
- Elegant and beautiful design
- Parallel connection of multiple collectors (up to 8)
- Multiple installation solutions available for any roof surface.
- Compliant with thermal energy account



Best global efficiency all year round with respect to any other solar system on the market. Better performance.

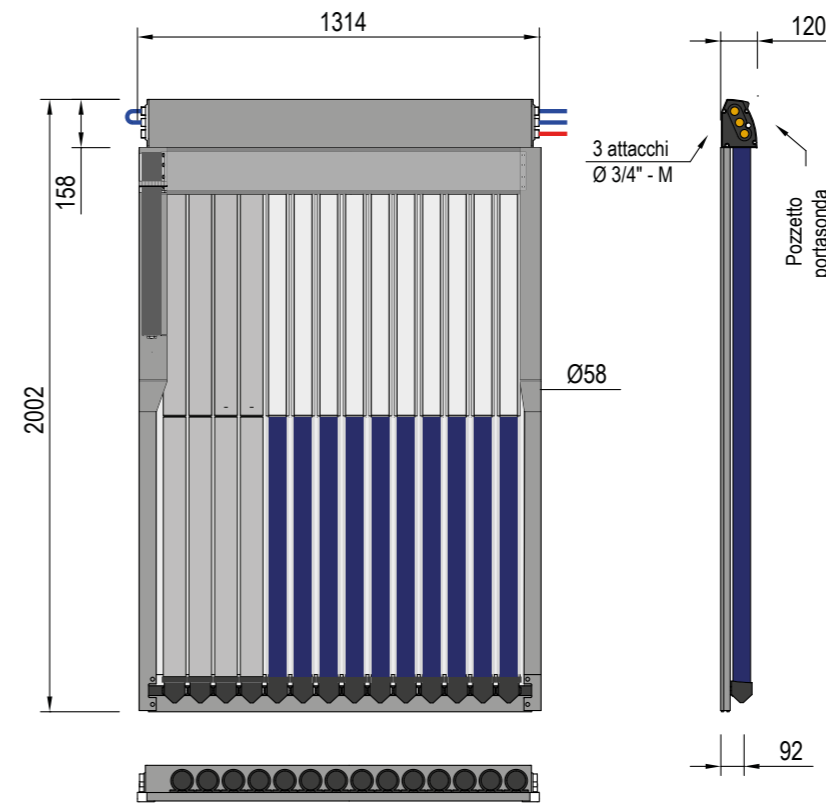

Exclusive technology THIRD INTEGRATED TUBE

Top class high-efficiency collectors, with evacuation technology and third tube integrated in the head (no visible return pipes).

+15% efficiency in parallel connection

Parallel connection (up to 8 ECLIPSE collectors) more efficient than traditional series connection.



MADE IN ITALY

ECLIPSE COVER SYSTEM Technology and ECLIPSE CONTROLLER are produced in Italy by PLEION.

10-YEAR WARRANTY

5+5* extendable COLLECTOR WARRANTY.

10 YEARS ANTI-HAIL PIPE WARRANTY

		ECLIPSE*
Size (length x width x height)	mm	1314x2002x119
Gross area	m ²	2,63
Aperture surface	m ²	1,33
Empty weight	kg	63
Contained liquid	l	2,83
Maximum working pressure	kPa	1000
Recommended collector flow rate	l/min	0,75
Peak inlet supply	W	974
Efficiency η_0	%	73,20
Transmission coefficient a_1	W/m ² K	0,518
Transmission coefficient a_2	W/m ² K ²	0,032
Hydraulic connection diameter	inch	6x3/4"

Data on PLEION X-AIR 14 collector alone, without ECLIPSE 2 COVER SYSTEM

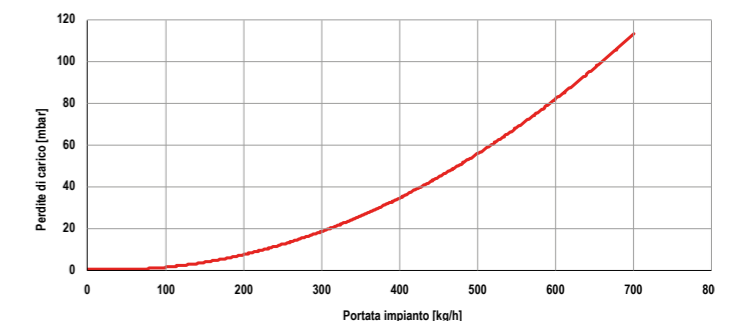

The revolutionary solar collector
with PLEION **ECLIPSE 2 COVER SYSTEM**.

The thermal solar: the key for your savings.



Trust the thermal solar for your heating system.
Now with the **ECLIPSE 2** technology it is finally possible
to heat up your house in a smart, relevant and totally safe way.

The ECLIPSE 2 thermal solar gives you the extraordinary advantage of heating domestic water, thus dramatically contributing to the energetic needs of a building.

The thermal solar as primary renewable source is now reality.

- A solar system with ECLIPSE 2 system and evacuated technology can support heating in a greater degree than other forms of renewable energy.
- The features of ECLIPSE 2 allow a reduction of the collector size, letting you install the thermal solar in spaces that were formerly too small.
- The special ECLIPSE 2 systems comply the current regulations on the integration of renewable energy established by 28/2011 Italian Ministry decree: 35% integration in heating and 50% on hot domestic water supply, in most types of buildings.



✓ HEATING



✓ DOMESTIC HOT WATER

Hot domestic water integration with heating. ECLIPSE 2 makes the thermal solar significantly cheaper increasing the percentage of the supply needs of thermal energy required for heating.

Power is useless without control.



Think big with ECLIPSE 2.

PLEION ECLIPSE 2 COVER SYSTEM solar collectors free your design creativity allowing the use of more collectors without worrying about overtemperature and stagnation. The great thermal solar systems with ECLIPSE 2 become the ideal solution for technical and planning of large solar systems for commercial and craft businesses, industries, food industry, hotels and estate trades.

Designers and installers obtain can trust a smart system that automatically prevents overtemperature and stagnation, all year round!

No other collector in the world can guarantee such an efficiency and reliability.

- Great high-efficiency systems for domestic hot water and heating integration.
- Cheaper investment than other sources of renewable energy.
- Dramatic reduction of operating and servicing costs of small, medium and large thermal solar systems.
- Tax incentives and deductions.

PLEION
Il n.1 del Solare Termico in Italia!

PLEION Srl
Smart Solar Systems
Via Venezia, 11 - Cerea Verona
infoline +39 0442 320295
info@pleion.it

ECLIPSE **Patent Pending**

www.pleion.it